

FEATURES

- * Reliable circuitry Insure high srability and accuracy.
- * Easy operation on vertical type panel assembling.
- * Frequency range from 10Hz to 1MHz selectable in 5 ranges are calibrated with single-scale graduations.
- * More than 5V rms at no load and more than 2.8V rms on 600 loading (sine Wave). Output level can be adjusted.by a 10dB-step, 6 range attenuator and a level adjuster.
- * Sine Wave and square waves in available.
- * Synchronizing input reminal.

SPECIFICATIONS

Frequency range:

- X 1 range : 10Hz- 100Hz
- X 10 range : 100Hz - 1 KHz
- X 100 range : 1KHz - 10KHz
- X 1K range : 10KHz- 100KHz
- X 10K range: 100KHz - 1MHz

Sine Wave Characteristics

- Output Voltage : 5V rms or more
- Output Distortion: 400Hz - 20KHz, 0.1% or Less
(X 100 range for 1KHz)
- 50Hz - 500KHz 0.5% or Less
- Output Flatness : ± 1.5 dB (refer to 1 KHz)

Square Wave Characteristics:

- Output Voltage: 10V p.p or more
- Rise Time: 0.25 us or Less
- Duty ratio: 50% 5% (refer to 1 KHz)

External Synchronization Characteristics

- Range $\pm 3\%$ of Oscillator frequency
- Input Impedance: 10K approximate
- Maximum Input: 10V Rms

Output Characteristics:

- Impedance: 600 Ω $\pm 10\%$
- Attenuator: 0dB, -10dB, -20dB, -30dB, -40dB and -50dB in 6 steps (assutacy+ 1dB at 600 Ω Load)

amplifier can be observed on an oscilloscope. To test an amplifier proceed as follows:

- 4.1 Connect the instrument, an amplifier to be tested and an oscilloscope as shown in Fig . 7.
- 4.2 Press WAVE FORM (8) to the position to obtain square waves of appropriate frequency and amplitude .
- 4.3 During the test, change the frequency as necessary .The relationship between waveforms and amplifier characteristics is shown in Fig .8.

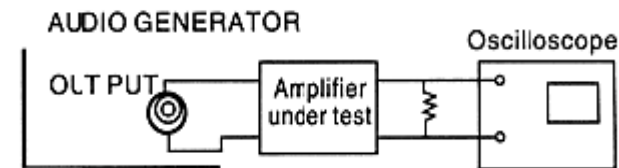

Fig.7

Output Waveform	Amplifier Characteristic	
	Flat frequency characteristic over 10times the input frequency.	
	Frequency of about 10 times the input frequency is cut off.	
	Frequency of about 1/10of the input frequency is cut off.	
	Peak appears on frequency of about 10times the input frequency.	

Fig.3

BLOCK B16/F KWAI FUNG INDUSTRIAL
BLDG NO.9-15 KWAI CHEONG ROAD KWAI

3. Square Wave Shaping Circuit

The square wave shaping circuit is a Schmit-trigger circuit in which the sine wave signal from the oscillator circuit is shaped into a square wave. Scj, ot-trigger circuit and a buffer amplifier providing sufficient rising and falling characteristics.

4. Output Circuit

The output circuit converts the impedance of oscillating signal from the OUTPUT control and feeds the signal to the output attenuator at a low impedance. SEPP-OCL circuit is employed to provide sufficiently low output impedance characteristics over the rang from DC to 1 MHz

5. Output Attenuator

The 6-positions output attenuator selects attenuations of 0dB to -50dB in 10dB steps. At the 0dB position with the OUTPUT control turnde fully ccookwise, the output voltage (sing wave at no-load tome) is more than 5V rms.

The output impedance is rated at around 600 and the attenuation accuracy is as highas ± 1.0 dB at a 600 Ω Load

6 Power Supply

The power supply circuit powered by AC 110V/220V and delivers DC ± 24 V sufficiently srabilized by large capacity smoothing capacitors and a voltage stabilizer.

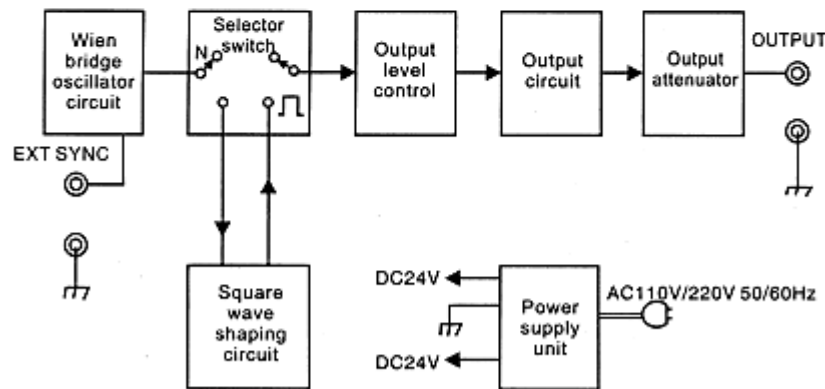

Fig. 1 Block Diagram

PANEL CONTROLS AND THEIR FUNCTIONS

The rable below describes the function of panel controls. Refer to panel

2.1 Adjust ATTENUATOR(4) and AMPLITUDE(9) so yjsy AC volt-meter indicates the rated output (supplsed to be 1V in this esample) of the amplifie. To facilitate the measurement, it is advisable to set ATTENUATOR(4) as low as possible. Assume that ATTENUATOR(4) is set -50dB for the rated output.

2.2 Disconnect the amplifier and connect the AC voltmeter to instrument to measute the output voltage. Note that the use of ATTENUATOR(4) eilminates the need for connecting a high sensitivity voltmeter. If ATTENUATOR(4) is set to 0dB and the voltmeter indicates 2V, it mens that the unput voltage of the amplifier is 50dB below 2V. Therefore, the gain obtained is as follows:

$$\begin{aligned} & 50\text{dB} + 20\log_{10} \frac{1\text{V}}{2\text{V}} \text{ dB} \\ & = 50\text{dB} - 6\text{dB} \\ & = 44\text{dB} \end{aligned}$$

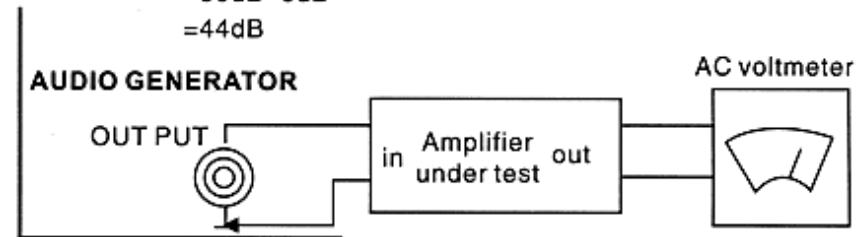

3. Measurement of Phase Characteristic

Connect the instrument and an oscilloscope to the amplifier to be tested as shown in Fig.5. If there is no phase shift about the output signal of the amplifier, the oscilloscope will display a straight line as shown in Fig. 5A. If the straight line on the oscilloscope is curved at its top and bottom sections as shown in Fig. 5B, it indicates that the output signal of amplifier is suffering from an amplitude distortion. In this case, reduce the output level of indtrument a little to vary the frequency. This causes the straight line on the oscilloscope to expand gradually to turn into an ellipse. By utilizing the configuration of this ellipse, the phase shift can be calculated as follows:

First, measure the maximum horizontal deflection and suppose that this deflection is "x" and that the section at which the ellipse crosses the horizontal axis is "x", as shown in Fig. 6. And, the phase shift angle is give by the following.

$$\sin \theta = \frac{X}{X}$$

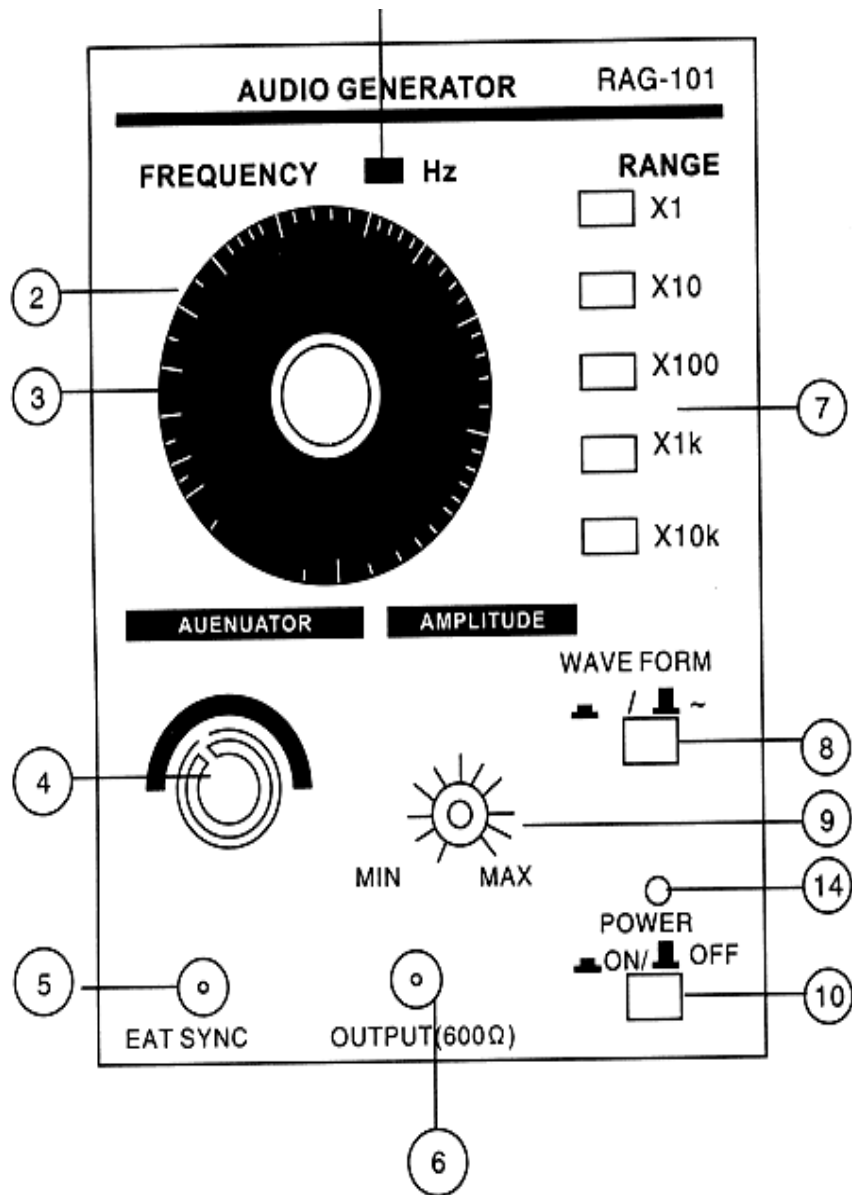

oscillating frequency can be synchronized to the external signal. Synchronizing range is increased in proportion as the input voltage is increased as shown in Fig. 3, indicating that the synchronizing range is about 1% per input voltage of 1V.

Example: Suppose that the input signal voltage is 1V rms and the oscillating frequency of GENERATOR is between 990Hz and 1010Hz ($1\text{kHz} \pm 1\text{kHz} \times 1\% / v \times 1\text{V} = 1\text{kHz} \pm 1\text{kHz} \times 0.01$), the frequency can be synchronized with 1kHz of the input signal.

Note that too high synchronizing signal voltage will affect the amplitude and distortion factor, and care must therefore be taken when the signal voltage is higher than 3Vrms. Also note that if the synchronizing signal is largely deviated from the frequency of instrument the synchronization is pulled out which affects the distortion factor. It is therefore advisable that the oscillating frequency be first synchronized with a low input signal voltage (less than 1V rms) and then the voltage be increased.

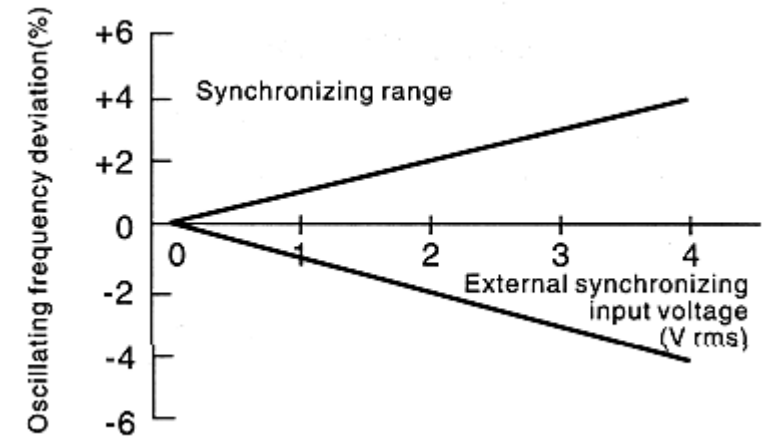

OPERATING INSTRUCTIONS

1. Start-up

First check that the fuse (13), then connect the supplied AC power cord to your AC outlet. Press the power switch (10) and the pilot lamp (14) will light indicating that unit is ready for operation. Allow 3 minutes for the unit to warm up so that it is stabilized.

2. Waveform Selection

Press the WAVE FORM switch (8) to "~" position to obtain sine waves. Press the switch to the "□" position for square waves.

3. Frequency Selection

First set the FREQ. RANGE switch (7) to the desired range, then set the frequency dial (3) so that the dial pointer (1) indicates your frequency.

Example: Suppose you want to select a frequency of 1.5 kHz, then proceed as follows:

1. Set FREQ. RANGE switch (7) to $\times 100$.
2. By using the frequency dial, set the dial pointer (1) to "15" on the dial scale.

The frequency thus selected is:
 $15 \times 100 = 1500 \text{ (Hz)} = 1.5 \text{ (kHz)}$

4. Adjustment of Output Voltage

The output voltage from OUTPUT terminal (6) either sine wave or square wave, can be continuously varied by AMPLITUDE (9) and stepped down by ATTENUATOR (4).

Example: TO adjust output voltage to 10 mV rms, proceed as follows:

1. Connect a voltmeter (e.g. TVT-321) capable of measuring AC 1 V rms to OUTPUT terminal (6)
2. Set ATTENUATOR (4) to 0 dB and then adjust AMPLITUDE (9) until the voltmeter indicates 1 V rms. A voltage of 1 V rms will appear at OUTPUT terminal (6)
3. Set ATTENUATOR (4) to -40 dB. The voltmeter indicates about 0 V, while a voltage of 10 mV rms appears at OUTPUT terminal (6)

5. Use of Synchronizing Input Terminal (Instrument is between 990 Hz and 1010 Hz)

By applying an external sine wave signal to SYNC terminal (5), the

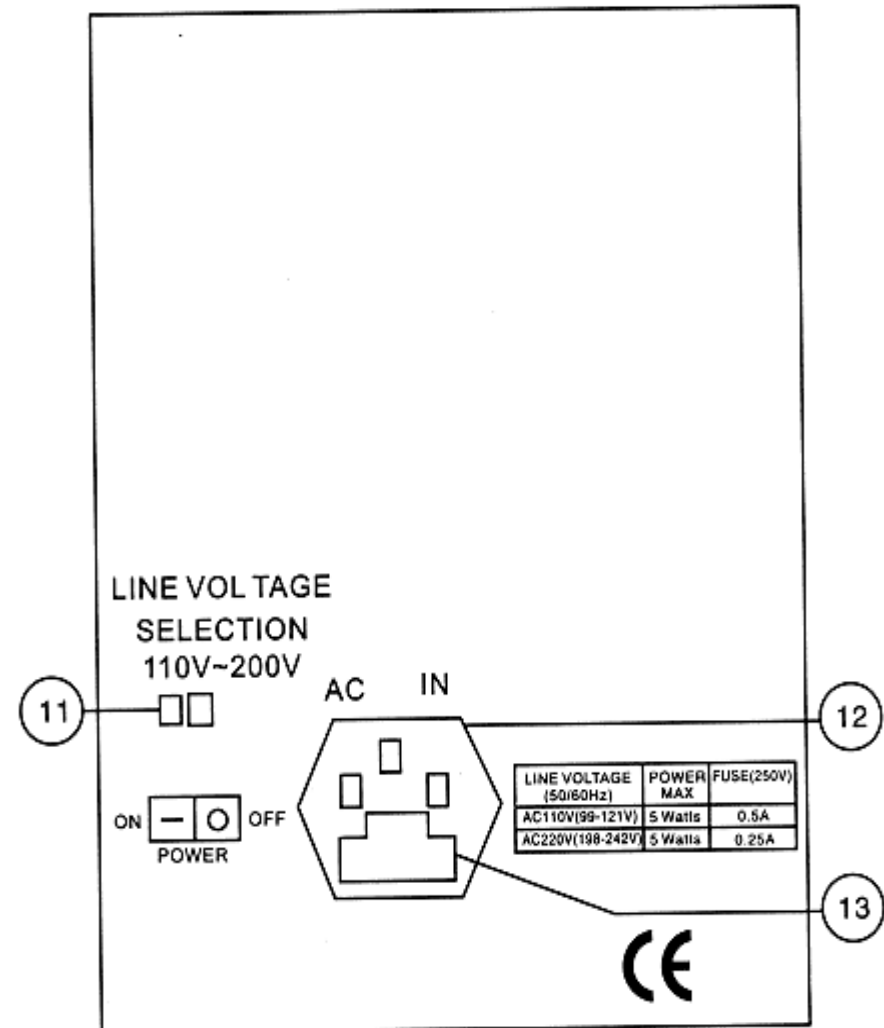

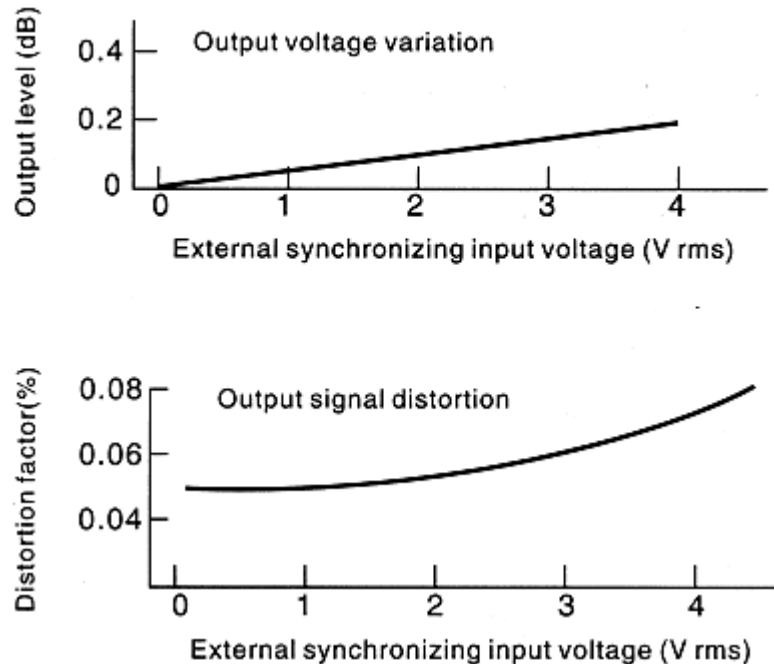

Fig. 3

APPLICATIONS

1. Using as Sine Wave Oscillator

As a sine wave oscillator, features can be noted as below.

- 1.1 Low distortion factor can be obtained for measurement of distortion characteristic of amplifier.
- 1.2 As the unit working on wide bandwidth, it can be used for measurement of frequency characteristic of amplifier.
- 1.3 The built-in high accuracy attenuator permits measurement of amplifier gain.
- 1.4 Can be used as a signal source of impedance bridge.

2. Measurement of Amplifier Gain

An example of measurement of amplifier gain is described below.

First connect the instrument, amplifier to be tested and AC volt-meter as shown in Fig. 4.

diagram on page 4.

FRONT PANEL

1. DIAL POINTER

This pointer indicates frequencies on the dial scale.

2. DIAL SCALE

This dial is calibrated with graduations of 10-100 to indicate oscillating frequencies.

3. FREQUENCY DIAL

This dial adjusts oscillating frequencies. Frequencies can be read by multiplying the reading on the dial scale by magnification of FREQ. RANGE.

4. ATTENUATOR

6-position output attenuator selects attenuations from 0dB to -50dB in 10dB steps.

5. SYNC

External synchronizing signal input terminals for GND for connection of synchronizing signal to the instrument.

6. OUTPUT

Output terminal used for both sine wave and square wave.

7. FREQ. RANGE

Oscillating frequency range selector switch which selects the ranges in 5 steps as follows:

X1	10Hz - 100Hz
X10	100Hz - 1KHz
X100	1KHz - 10kHz
X1K	10KHz - 100kHz
X10K	100KHz - 1MHz

8. WAVE FORM

Output waveform selector switch. When pressed to "∩" output signal is sine wave. When pressed to "⌋" the signal is square wave.

9. AMPLITUDE

Amplitude adjuster to continuously vary the amplitude of output voltage.

10. POWER

Switch turns on the power when pressed

11. VOLTAGE SELECTOR

110V/220V selection

12. AC INPUT TERMINAL.

13. FUSE SOCKET

14. This lamp (light emitting diode) lights when POWER switch (10) is ON.

Find from the table of trigonometric functions and the value obtained gives the angle of phase shift

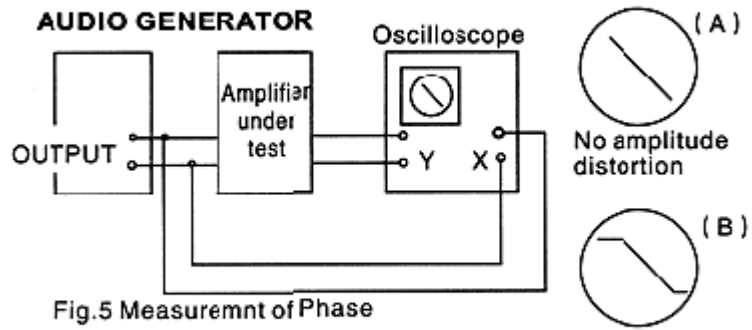

Fig.5 Measurement of Phase Characteristic

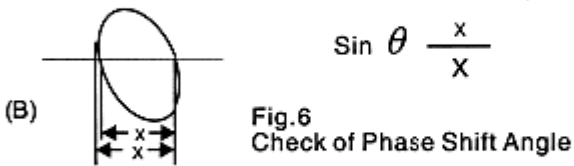
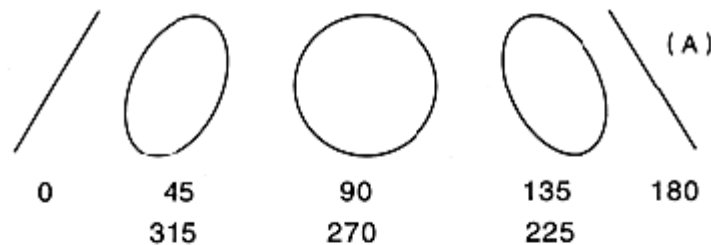

Fig.6 Check of Phase Shift Angle

4. Using as Square Wave Oscillator

The instrument features excellent rising and falling characteristics (120 ns as standard characteristic). It has no coupling capacitors in the output stage so the sag (deflection of top section) is as low as 5% at 50Hz. By applying such a good square wave to an amplifier input, various characteristics of

Power Requirement:

Input: AC 110V or 220V, 50/60 Hz

Consumption: 5 Watt

Dimension:

142(W)×233 (D) ×197 (H) mm

3.5kg

Accessories:

Power Cord 1 pc.

Test Clip 1 pc.

Instruction Manual 1 pc.

4

CIRCUIT DESCRIPTION

1. Summary

When reading the following descriptions, refer to the block diagram (Fig.1) and the schematic diagram.

The sine-wave signal generated by the oscillator is fed through the WAVE FORM selector switch set at the "N" position to the OUTPUT control, to adjust on any desired voltage.

If the WAVE FORM switch is in the "□" position, square wave is fed to the OUTPUT control to adjust on any desired voltage.

The adjusted signal voltage is applied to the output circuit with its impedance, converted, and then delivered through an output attenuator to the output terminal. The attenuator provides selectable attenuations of 0dB through -50dB in 10dB steps at 600Ω of output impedance.

2. Wien Bridge Oscillator Circuit

The Wien bridge oscillator circuit with resistance elements may be switched over for 5 ranges by the FREQ. RANGE switch, and the variable capacitor controlled by the FREQUENCY dial.

These elements provide means to vary the oscillating frequency continuously over 10 times its frequency on one range, so any desired frequency within the entire frequency range from 10Hz to 1 MHz can be set.

The buffer circuit for the oscillator circuit is composed of a 2-stage differential amplifier and an output stage, employing an DC amplifier circuit.

The output voltage is fed back with positive polarity through the oscillator elements to form an oscillating circuit, while it is also fed back with negative polarity through the non-linear thermistor to stabilize the amplitude.